



## TECE drain profile shower profile

Article number: 671200

Length: 1200 mm

Width: 55 mm

Surface: brushed

DU 1: 1 pc.

## Description:

Shower profile for shower drainage, for installation in tile adhesive above the screed and seal.

Consisting of:

- Shower profile that can be cut to length made of stainless steel, with internal incline for improved water drainage and self-cleaning effect, material 1.4301 (304)
- Shower profile can be shortened to  $\geq 500$  mm
- Profile lid made of stainless steel, with "Push Function" for removal by hand, material 1.4301 (304), durable to load class K3 - maximum test load 300 kg
- Connection piece for connection with a TECE drain profile drain
- Grip elements for easy installation and solid connection with the tile adhesive
- For floors from 8-25 mm (incl. adhesive bed)
- For flush to the wall installation for wall coverings from 10 mm (incl. adhesive bed)
- For installation at the wall (flush to the wall) or at any specific distance from the wall

## Sales data:

Product name: TECE drain profile shower profile, 1200 mm, brushed stainless steel  
 Commodity group: 608  
 Product group: 3006080010

## Dimensional drawings:

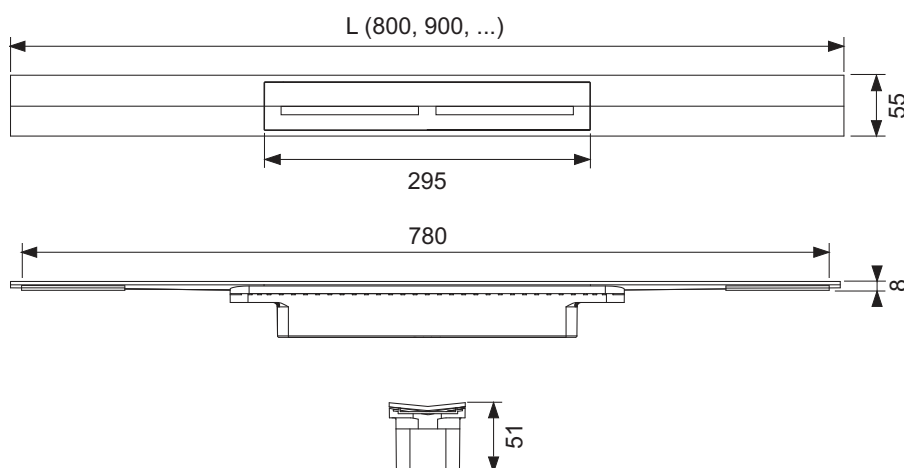

**Spare parts:**



- 1 675000      Profiled cover in stainless steel, brushed