

S71

S719-U500 Under-mount sink 500

Surfaces: **Stainless Steel** Article Number: **43427800**



Description

product features

- cut-out dimensions: 498 x 398 mm
- material: stainless steel
- number of bowls: 1 main bowl
- without tap hole
- cabinet size: 60 cm
- type of installation: undermount, flat on the countertop (self-rimming) or flush-mount installation
- position overflow: on the right side of the bowl
- corner radius: 10 mm
- sink depth: 190 mm
- waste set not included - please order one waste set from the required parts

Product image



Scale drawing

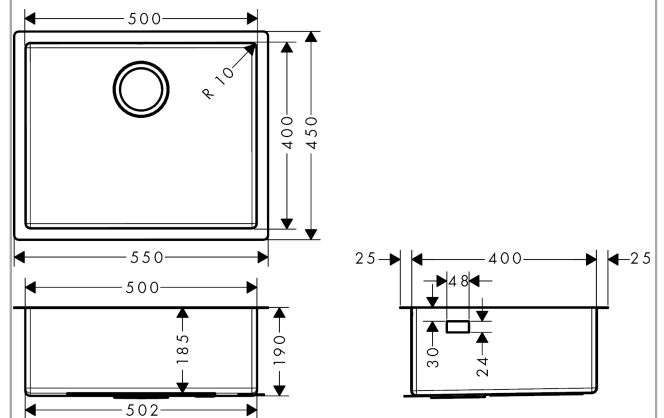

S71

S719-U500 Under-mount sink 500

Surfaces: **Stainless Steel** Article Number: **43427800**



Exploded Drawing

Year of production: >04/21

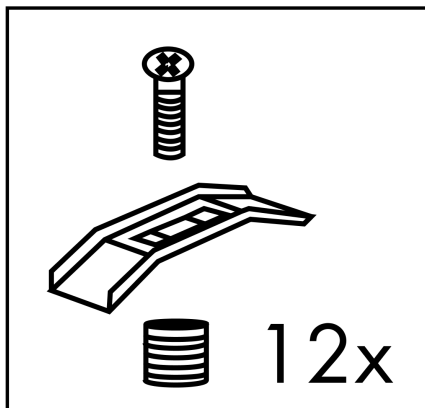
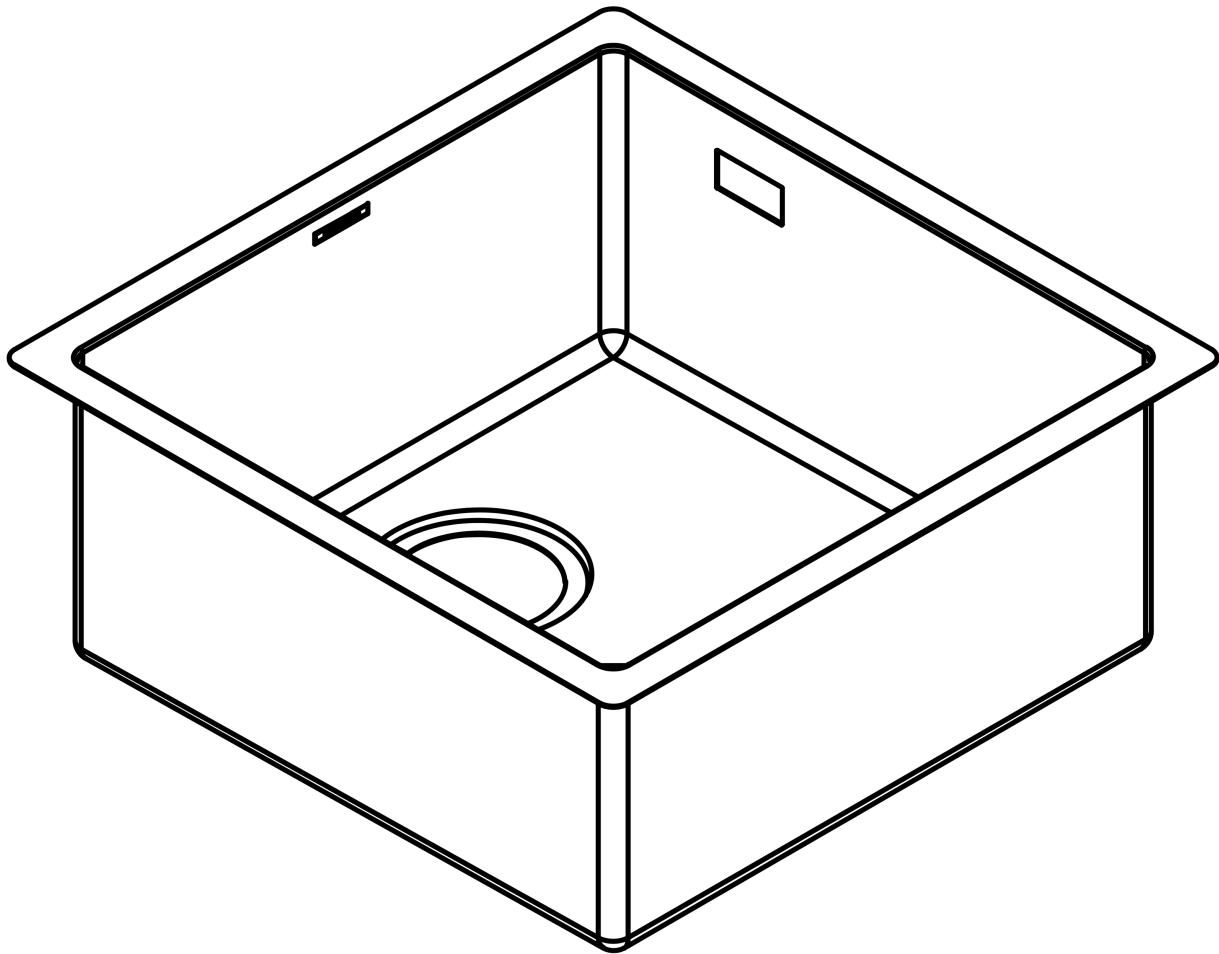

1

S71

S719-U500 Under-mount sink 500

Surfaces: **Stainless Steel** Article Number: **43427800**



Spare part list

Year of production: >04/21

Pos.	Description	Article Number	Price	PU
1	mounting kit	93180000	-	1