



TECEdrainline shower channel, straight, with Seal System sealing tape

Article number: 600700

Nominal length: 700 mm
 Total length L: 711 mm
 Visible dim. after installation: 651 mm
 Width in unfinished state: 150 mm
 Visible width after installation: 71 mm
 DU 1: 1 pc.
 DU 2: 40 pc.

Description:

Straight channel body for installation in the screed, with flange and Seal System sealing tape, for creating an independently tested connection of the TECEdrainline shower channel to the composite seal.

Consisting of:

- Channel body with flange made of polished stainless steel, material 1.4301 (304)
- Seal System sealing tape with matting for installation by the customer in the liquid or strip composite seal
- Connecting clips for anchoring in the screed and fitting of optional assembly feet
- Central connection pieces for drain
- Internal incline for improved water drainage and self-cleaning effect
- Seal

Sales data:

Product name: TECEdrainline shower channel, straight, 700 mm with Seal System sealing tape
 Commodity group: 600
 Product group: 3006000010

Dimensional drawings:

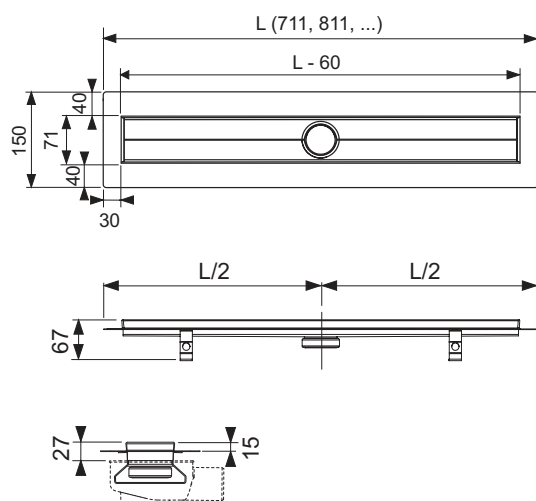

Spare parts:

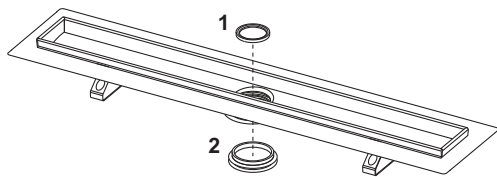

- | | | |
|---|--------|---|
| 1 | 668012 | Immersion pipe seal |
| 2 | 668013 | Seal between channel and outlet, until 2015 |